

↓ PRODUCT DESCRIPTION

Part of the D range, with its specific articulation, this unique small spot is emblematic of Loupi expertise. Used for accent lighting, it exploits the advantages of LED technology to the full: less bulk, lower energy consumption and greater efficiency. a small unit that lights like a big one.

↓ OUTPUT (PEG)

3W

↓ OUTPUT (TRACK, RCA)

3.5W

↓ CRI

IRC90

↓ USE

↓ IP

IP 40

↓ POWER SUPPLY (PEG)

700mA

↓ LUMENS

300lm

↓ ADJUSTABLE DEGREES

10° 18° 28° 40° ELL

↓ POWER SUPPLY (TRACK, RCA)

24V

↓ DIMMING

1-10V BALL CASAMBI DMX

↓ COLOUR TEMPERATURE

2400K 2700K 3000K 3500K 4000K 5000K

↓ STANDARDS COMPLIANCE

EN 62471 EN 60598-1 EN 60598-2 CE III

↓ COLOURS

BK WH CUSTOM

↓ SOURCES

- Luminous flux according to Bining: 300 lumens
- Colour temperature : de 2400K to 5000K
- Service Range: 70 % of nominal flux after 50 000 hours
- Colour Rendering Index: CRI 90

↓ OPTICAL

- PMMA acrylic lens, efficiency ~90%
- Available degrees : 10°, 18°, 28°, 40° et Elliptic

↓ ELECTRICAL (on peg)

- Power supply 700mA
- Reversible polarity and hot plug
- Power consumption to 3W max, excluding supply
- Electrical Classification : Class III SELV device

↓ ELECTRICAL (on tracks or RCA)

- Power supply 24V
- Electric transmission by magnetic contact
- Reversible polarity and hot plug
- Power consumption to 3.5W max, excluding supply
- Electrical Classification : Class III SELV device

↓ MECHANICAL

- Electronic circuit encased in a fire-proof polycarbonate housin
- Fixing by magnetic contact (on track)
- Operating temperature : -5° +40°
- Articulating base
- ROHS components
- Interior use only

↓ SPECIFICITIES

- 3 years guarantee

↓ NOMENCLATURE

Product Ref.	SD001		
Specification	Simple peg	A	
	RCA	ARCA	
	Piccolo track	P	
	Slim track magnet	SMA	
Degrees	10°		10
	18°		18
	28°		28
	40°		40
	Elliptic		ELL
Colour	Black		BK
	White		WH
	Custom		CU
Temperature	2400K		24
	2700K		27
	3000K		30
	3500K		35
	4000K		40
	5000K		50
REFERENCE	SD001	P	28 BK 27

BEAM ANGLE

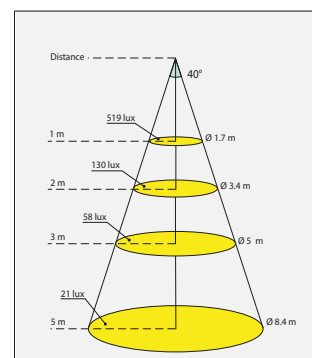
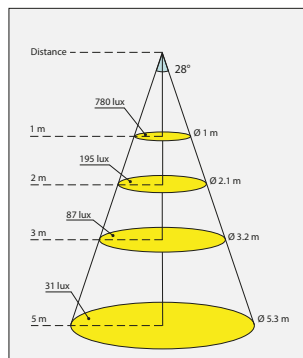
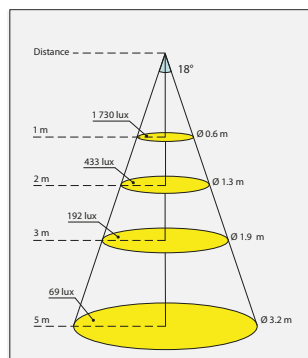
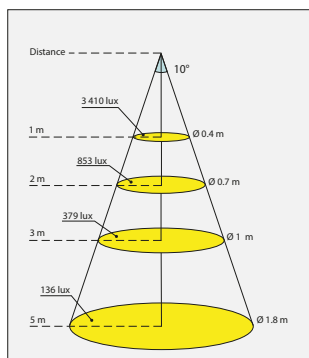

Spot D

MOUNTING CONFIG.

REF : SD001

SPOT EN

↓ MOUNTING CONFIGURATION

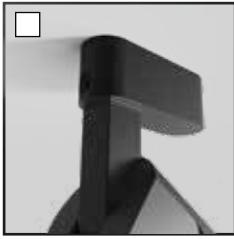

SD001A
Fixing mounting simple
(except BA13)



SD001SMA
Slim track Width 13mm



SD001P
Piccolo track Width 27mm



SD001ARCA
RCA

**RCA ACCESSORY
NEXT PAGE**

**ACCESSORY (OPTIONAL)
TO BE ADDED TO THE
«FIXING MOUNTING SIMPLE»**



ACSFIPATER43XXENCC
Fixing mounting recessed
(driver out)
Ø43mm H34mm



ACSFIPATER60XXENCC
Fixing mounting recessed
(driver in)
Ø60mm H34mm



ACSFIPATER43XXAPPC
Fixing mounting ceiling
(driver out)
Ø43mm H30mm



ACSFIPATER70XXAPPC
Fixing mounting ceiling
(driver in)
Ø70mm H42.5mm

↓ EXAMPLE OF CONFIGURATION

SPOT D - FIXING MOUNTING SIMPLE + FIXING MOUNTING RECESSED Ø60 - **NOIR**
= SD001A-ACSFIPATER60**BK**ENCC

Spot D

RCA ACCESSORIES

REF : SD001

SPOT EN

↓ MOUNTING RCA TRIMLESS SPOT

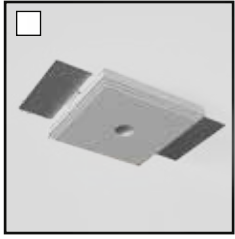

ACSD-RCA-PLA-13
RCA recessed trimless plug
Plaster 13mm

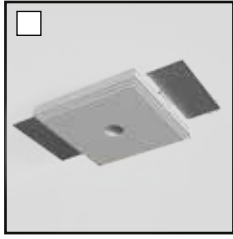

ACSD-RCA-PLA-18
RCA recessed trimless plug
Plaster 18mm

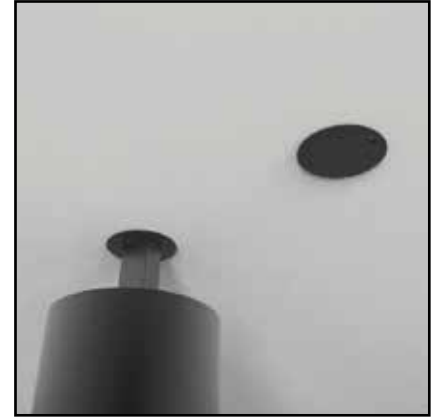
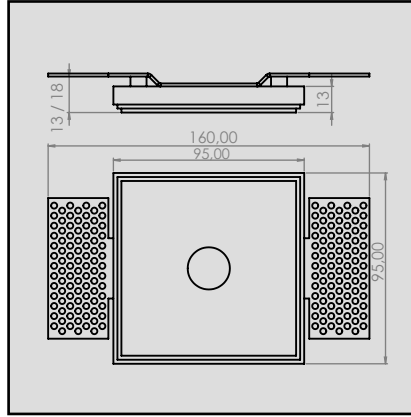

IN SITUATION



ACCOVERRCA TLXXC
RCA cover trimless

↓ MOUNTING RCA TRIM SPOT



ACSD-RCA
RCA peg female (trim)

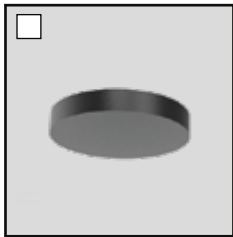

ACSD-RCA-CO
RCA cover trim

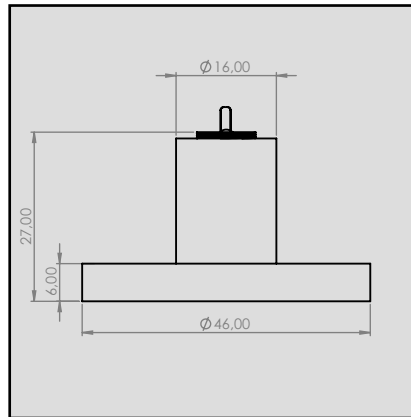

IN SITUATION

Spot D

ACCESSORIES

REF : SD001

SPOT EN

↓ CONNECTORS INDEPENDENT CONNECTION TO BATTERIES

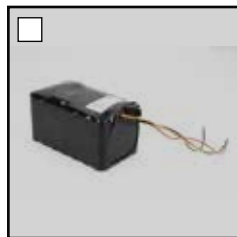

ACSD001COPLITHXX010
Pack Lithium 10,4Ah



ACSD001COCLITHXX35
Charger Pack Lithium
Charger 29,4V 3,5A

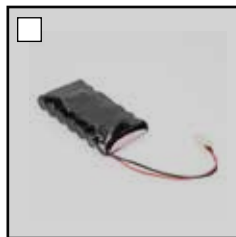

ACSD001COPLITHXX26
Pack Lithium 2,6Ah



ACSD001COCLITHXX06
Charger Pack Lithium
Charger 29,4V 0,6A

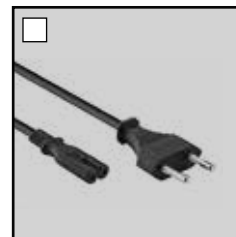

EUROPLUG

POWER SUPPLY CONNECTORS



ACSD001COCIRCPXX500
Piccolo circuit with sheath
heat-shrinkable

↓ OPTICAL ACCESSORIES

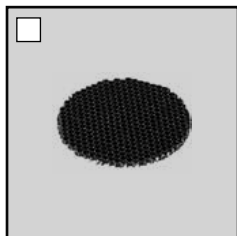

ACSC001OPNIDABBKD28C
Honey comb D28mm



ACSD001OPSNOOTBK550C
Snoot spot D 55mm