

↓ PRODUCT DESCRIPTION

This minispot, with its articulation specific to the «D» range, is particularly popular among commercial architects and stage designers for its high efficiency and small size. Its discreet, elegant design offers a wide range of optical characteristics, colour temperatures, and finishes, and thus many possible configurations.

↓ OUTPUT (PEG)

2.1W

↓ OUTPUT (TRACK, RCA)

2.6W

↓ CRI

IRC90

↓ USE

↓ IP

IP 40

↓ POWER SUPPLY (PEG)

700mA

↓ LUMENS

200lm

↓ ADJUSTABLE DEGREES

10°  29°  48°  ELL

↓ POWER SUPPLY (TRACK, RCA)

24V

↓ DIMMING

1-10V  BALL  CASAMBI  DMX

↓ COLOUR TEMPERATURE

2400K  2700K  3000K  3500K  4000K  5000K

↓ STANDARDS COMPLIANCE

EN 62471  EN 60598-1  EN 60598-2  CE  III

↓ COLOURS

BK  WH  CUSTOM

↓ SOURCES

- Luminous flux according to Bining: 200 lumens
- Colour temperature : de 2400K to 5000K
- Service Range: 70 % of nominal flux after 50 000 hours
- Colour Rendering Index: CRI 90

↓ OPTICAL

- PMMA acrylic lens, efficiency ~90%
- Available degrees : 10°, 29°, 48° et Elliptic

↓ ELECTRICAL (on peg)

- Power supply 700mA
- Reversible polarity and hot plug
- Power consumption to 2.1W max, excluding supply
- Electrical Classification : Class III SELV device

↓ ELECTRICAL (on tracks or RCA)

- Power supply 24V
- Electric transmission by magnetic contact
- Reversible polarity and hot plug
- Power consumption to 2.6W max, excluding supply
- Electrical Classification : Class III SELV device

↓ MECHANICAL

- Electronic circuit encased in a fire-proof polycarbonate housin
- Fixing by magnetic contact (on track)
- Operating temperature : -5° +40°
- Articulating base
- ROHS components
- Interior use only

↓ SPECIFICITIES

- 3 years guarantee

↓ NOMENCLATURE

Product Ref.	SD002				
Specification	Simple peg	A			
	RCA	ARCA			
	Piccolo track	P			
	Slim track magnet	SMA			
Degrees	10°			10	
	29°			29	
	48°			48	
	Elliptic			ELL	
Colour	Black			BK	
	White			WH	
	Custom			CU	
Temperature	2400K				24
	2700K				27
	3000K				30
	3500K				35
	4000K				40
	5000K				50
REFERENCE	SD002	P	48	BK	27

## BEAM ANGLE

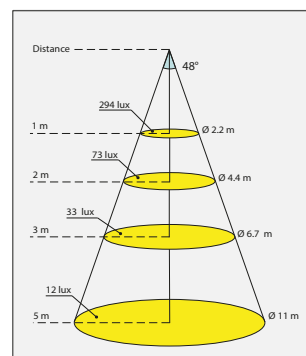
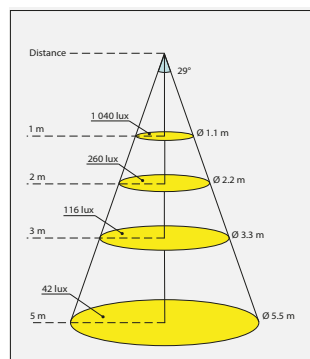
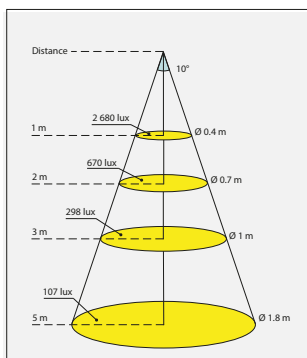

# Spot mini D

## MOUNTING CONFIG.

REF : SD002

SPOT EN

### ↓ MOUNTING CONFIGURATION

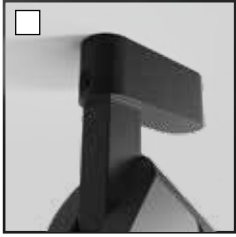

**SD002A**  
Fixing mounting simple  
(except BA13)



**SD002SMA**  
Slim track Width 13mm



**SD002P**  
Piccolo track Width 27mm



**SD002ARCA**  
RCA

**RCA ACCESSORY  
NEXT PAGE**

**ACCESSORY (OPTIONAL)  
TO BE ADDED TO THE  
«FIXING MOUNTING SIMPLE»**



**ACSFIPATER43XXENCC**  
Fixing mounting recessed  
(driver out)  
Ø43mm H34mm



**ACSFIPATER60XXENCC**  
Fixing mounting recessed  
(driver in)  
Ø60mm H34mm



**ACSFIPATER43XXAPPC**  
Fixing mounting ceiling  
(driver out)  
Ø43mm H30mm



**ACSFIPATER70XXAPPC**  
Fixing mounting ceiling  
(driver in)  
Ø70mm H42.5mm

### ↓ EXAMPLE OF CONFIGURATION

SPOT D - FIXING MOUNTING SIMPLE + FIXING MOUNTING RECESSED Ø60 - **NOIR**  
= SD001A-ACSFIPATER60**BK**ENCC

# Spot mini D

## RCA ACCESSORIES

REF : SD002

SPOT EN

### ↓ MOUNTING RCA TRIMLESS SPOT

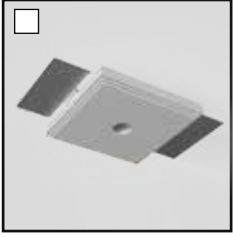

**ACSD-RCA-PLA-13**  
RCA recessed trimless plug  
Plaster 13mm

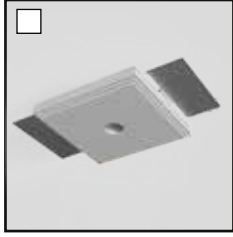

**ACSD-RCA-PLA-18**  
RCA recessed trimless plug  
Plaster 18mm

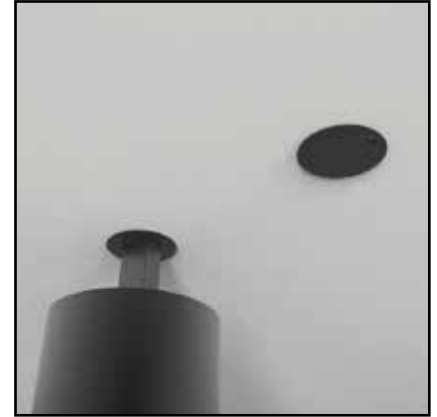
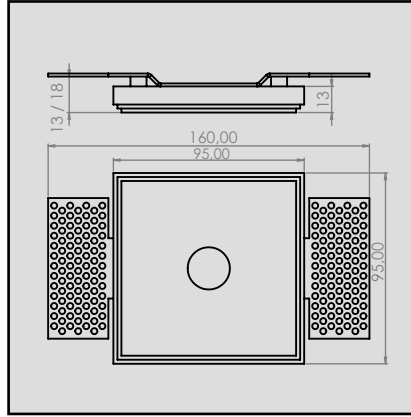

IN SITUATION



**ACCOVERRCA TLXXC**  
RCA cover trimless

### ↓ MOUNTING RCA TRIM SPOT



**ACSD-RCA**  
RCA peg female (trim)

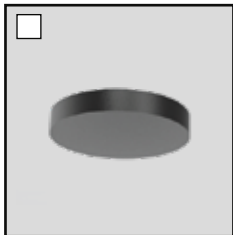

**ACSD-RCA-CO**  
RCA cover trim

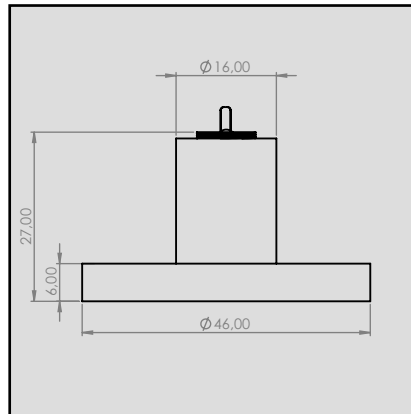

IN SITUATION

# Spot mini D

## ACCESSORIES

REF : SD002

SPOT EN

### ↓ CONNECTORS INDEPENDENT CONNECTION TO BATTERIES

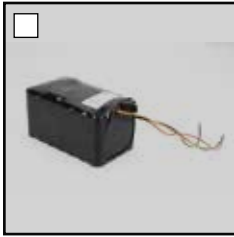

**ACSD002COPLITHXX010**  
Pack Lithium 10,4Ah



**ACSD002COCLITHXX35**  
Charger Pack Lithium  
Charger 29,4V 3,5A



**ACSD002COPLITHXX26**  
Pack Lithium 2,6Ah



**ACSD002COCLITHXX06**  
Charger Pack Lithium  
Charger 29,4V 0,6A

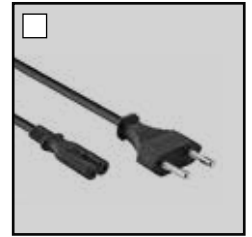

**EUROPLUG**

### POWER SUPPLY CONNECTORS



**ACSD002COCIRCPXX500**  
Piccolo circuit with sheath  
heat-shrinkable

### ↓ OPTICAL ACCESSORIES

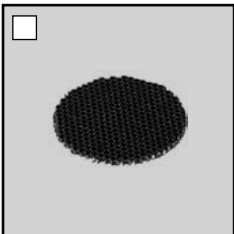

**ACCSD2NIDABBK023C**  
Honey comb D23mm