

↓ DESCRIPTION PRODUIT

Le spot D10 est modulable grâce à ses 4 options :

- le cadreur
- les lentilles interchangeables
- le wallwasher
- le zoom

↓ PUISSANCE (PATERE)

10W

↓ ALIM. (PATERE)

1A

↓ DEGRÉS (CADREUR / WALLWASHER / ZOOM)



↓ USAGE



↓ PUISSANCE (RAILS, RCA)

12W

↓ ALIM. (RAILS, RCA)

24V

↓ DEGRÉS (LENTILLES INTERCHANGEABLES)



↓ IRC



↓ GRADATION



↓ TEMPÉRATURES DE COULEUR



↓ IP



↓ NORMES ET SÉCURITÉ



↓ COLORIS



↓ SOURCES

- Flux lumineux : Max 9000cd dans l'axe (1000lm)
- Température de couleur : De 2700K à 4000K
- Vieillessement : 70% du flux nominal après 50 000 heures
- Indice de rendu des couleurs : IRC 90

↓ OPTIQUES

- Lentille PMMA (wallwasher et lentilles interchangeables)
- Lentille verre (cadreur et zoom)
- Lentilles interchangeables : 10°, 15°, 25°, 35° et ELL
- Focale réglable : 15° et 30° (cadreur)
- Focale réglable : 8° et 35° (zoom)

↓ ÉLECTRIQUES

- Alimentation 900mA ou 24V (sur patère et RCA)
- Alimentation 24V (sur rail slim et piccolo)
- Alimentation 220V (900mA) (sur rail 220)
- Puissance électrique lumineuse jusqu'à 10W

↓ MÉCANIQUES

- Porte filtre (cadreur et zoom)
- Porte GOBO (uniquement sur cadreur)
- Pied articulé
- Température ambiante d'utilisation : -5° +40°
- Composant ROHS
- Usage intérieur uniquement

↓ SPÉCIFICITÉS

- Traitements électrolytiques possibles
- Garantie 3ans

↓ NOMENCLATURES SPOT

Référence produit		SD010			
Spécification produit	Patère simple		A		
	Rail piccolo (variateur)		PVA		
	Rail slim		S		
	Rail 220 0-10V		RV		
	Rail 220 DALI		RD		
	RCA		ARCA		
Colori	Noir			BK	
	Blanc			WH	
	Custom			CU	
Température	2700K			27	
	3000K			30	
	3500K			35	
	4000K			40	
RÉFÉRENCE		SD010	PVA	BK	27

↓ NOMENCLATURES ACCESSOIRES OPTIQUES

Référence produit		ACSD10		
Spécification produit	Cadreur		CADRE	
	Wallwasher		WALLW_C	
	Zoom		LENSF10C	
	Lentilles inter. (10°)		PORTL_10C	
	Lentilles inter. (15°)		PORTL_15C	
	Lentilles inter. (25°)		PORTL_25C	
	Lentilles inter. (35°)		PORTL_35C	
	Lentilles inter. (ELL)		PORTL_ELC	
Colori	Noir			BK
	Blanc			WH
	Custom			CU
RÉFÉRENCE		ACSD10	CADRE	BK

Spot D10

CONFIG MONTAGE

REF : SD010

SPOTS FR

↓ CONFIGURATION MONTAGE



SD010PVA
Rail piccolo variateur
Largeur 27mm

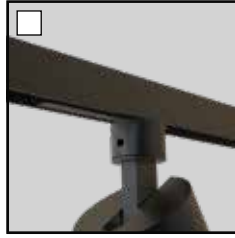

SD010SMA
Rail slim Largeur 13mm

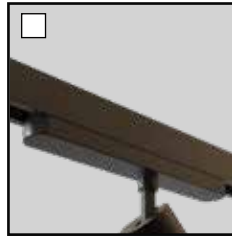

SD010RV
Rail 220 0-10V Largeur 31mm

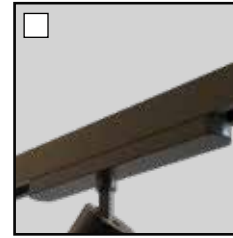

SD010RD
Rail 220 DALI Largeur 31mm



SD010ARCA
RCA



SD010A
Patère simple
(except BA13)
Ø35mm H21mm

↓
**OPTION RCA,
PAGE SUIVANTE**

↓
**ACCESSOIRE (FACULTATIF)
A AJOUTER A LA
PATERE SIMPLE**



ACSFIPATER43XXENCC
Patère encastrée (driver déporté)
Diamètre 43mm Hauteur 34mm



ACSFIPATER60XXENCC
Patère encastrée (driver intégré)
Diamètre 60mm Hauteur 34mm

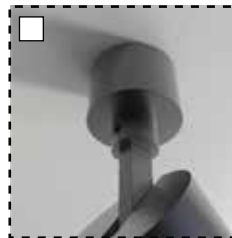

ACSFIPATER43XXAPPC
Patère apparente (driver déporté)
Diamètre 43mm Hauteur 30mm

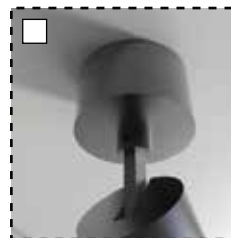

ACSFIPATER70XXAPPC
Patère apparente (driver intégré)
Diamètre 70mm Hauteur 42.5mm

↓ EXEMPLE DE CONFIGURATION

SPOT D - PATERE SIMPLE + ACCESSOIRE PATERE ENCASTREE D60 - **NOIR**
= SD001A-ACSFIPATER60**B**KENCC

ACCESSOIRES RCA

↓ MONTAGE SPOTS RCA TRIMLESS

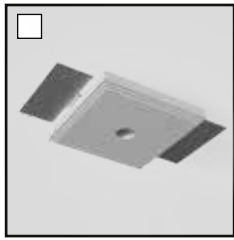

ACSD-RCA-PLA-13
Prise RCA encastrée trimless
plâtre EP13mm

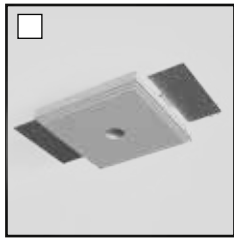

ACSD-RCA-PLA-18
Prise RCA encastrée trimless
plâtre EP18mm

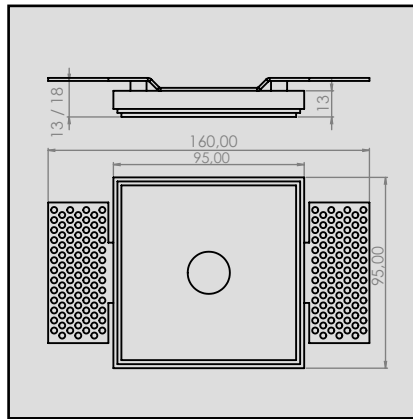

EN SITUATION

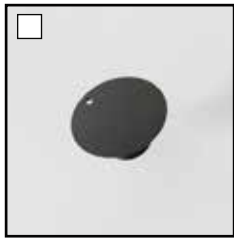

ACCOVERRCA TLXXC
Cover RCA trimless

↓ MONTAGE SPOTS RCA TRIM



ACSD-RCA
Patère RCA femelle (TRIM)

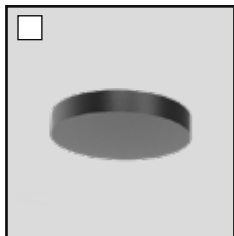

ACSD-RCA-CO
Cover RCA trim

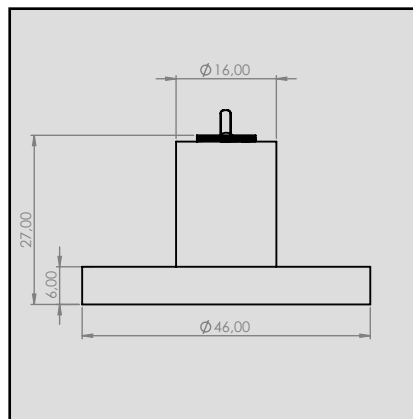

EN SITUATION

Spot D10

ACCESSOIRES

REF : SD010

SPOT FR

↓ CONNECTIQUES BRANCHEMENT AUTONOME SUR BATTERIES

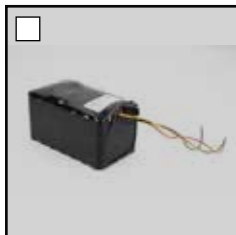

ACSD010COPLITHXX010
Pack Lithium 10,4Ah



ACSD010COCLITHXX35
Charger Pack Lithium
Charger 29,4V 3,5A

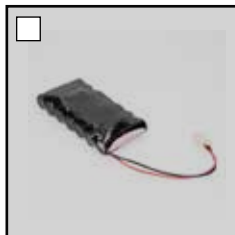

ACSD010COPLITHXX26
Pack Lithium 2,6Ah



ACSD010COCLITHXX06
Charger Pack Lithium
Charger 29,4V 0,6A

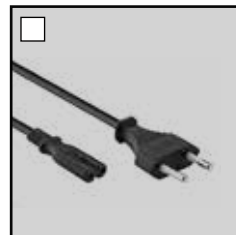

EUROPLUG

↓ CONNECTIQUES ALIMENTATION EN 24V



ACSD010COCIRCPXX500
Circuit piccolo avec
gaine thermorétractable

↓ ACCESSOIRE OPTIQUE



ACSD10CADREXXC
Cadreur



ACSD10LENSF10C
Zoom



ACSD10PORTLXXXXC
Lentilles interchangeables

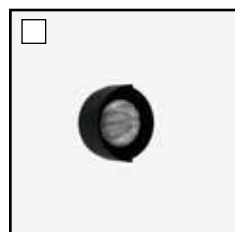

ACSD10WALLWXXC
Wallwasher



ACSD10OPTFILBKELC
Filtre oval



ACSD10OPTFILBKC-C
Filtre CTO-



ACSD10OPTFILBKC+C
Filtre CTO+