

↓ PRODUCT DESCRIPTION

Spot D12 - Powerful LED accent and architectural round spotlight with adjustable aluminium body. Threaded safety lock. Passive heat dissipation for source temperature control preserving LED life. Interchangeable lenses (15°, 25°, 40°, 50° Elliptical) by simple magnetic contact.

↓ OUTPUT (PEG)

12W

↓ OUTPUT (TRACK, RCA)

14.5W

↓ CRI

IRC90

↓ USE

↓ IP

IP 40

↓ POWER SUPPLY (PEG)

1A

↓ LUMENS

1200lm

↓ ADJUSTABLE DEGREES

15° 25° 40° 50° ELL

↓ POWER SUPPLY (TRACK, RCA)

24V

↓ DIMMING

1-10V BALL CASAMBI DMX

↓ COLOUR TEMPERATURE

2700K 3000K 3500K 4000K

↓ STANDARDS COMPLIANCE

EN 62471 EN 60598-1 EN 60598-2 CE III

↓ COLOURS

BK WH CUSTOM

↓ SOURCES

- Luminous flux according to Bining: **1200 lumens**
- Colour temperature : de **2700K to 4000K**
- Service Range: 70 % of nominal flux after 50 000 hours
- Colour Rendering Index: CRI 90

↓ OPTICAL

- PMMA acrylic lens, efficiency ~90%
- Available degrees : **15°, 25°, 40°, 50° et Elliptic**

↓ ELECTRICAL (on peg)

- Power supply **1A**
- Reversible polarity and hot plug
- Power consumption to **12W** max, excluding supply
- Electrical Classification : Class III SELV device

↓ ELECTRICAL (on tracks or RCA)

- Alimentation 24V
- Electric transmission by magnetic contact
- Reversible polarity and hot plug
- Power consumption to **14.5W** max, excluding supply
- Electrical Classification : Class III SELV device

↓ MECHANICAL

- Electronic circuit encased in a fire-proof polycarbonate housin
- Fixing by magnetic contact (on track)
- Operating temperature : -5° +40°
- Articulating base
- ROHS components
- Interior use only

↓ SPECIFICITIES

- 3 years guarantee

↓ NOMENCLATURE

Product Ref.	SD012				
Specification	Patère simple		A		
	RCA		ARCA		
	Rail piccolo		P		
	Rail slim magnétique		SMA		
	Rail 220 1-10V		RV		
	RAIL 220 DALI		RD		
Degrees	15°			15	
	25°			25	
	40°			40	
	50°			50	
	Elliptic			ELL	
Colour	Noir				BK
	Blanc				WH
	Custom				CU
Temperature	2700K				27
	3000K				30
	3500K				35
	4000K				40
REFERENCE	SD012	P	40	BK	27

BEAM ANGLE

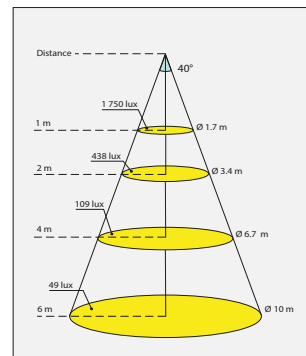
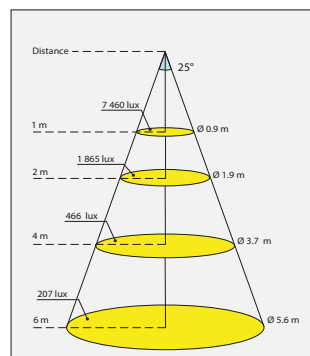
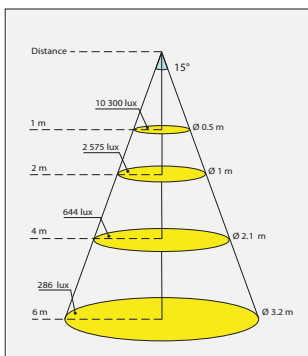

Spot D12

MOUNTING CONFIG.

REF : SD012



↓ MOUNTING CONFIGURATION



SD012P
Piccolo track Width 27mm

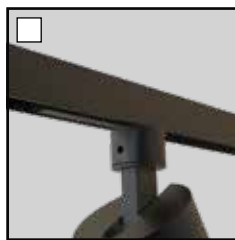

SD012SMA
Slim track Width 13mm

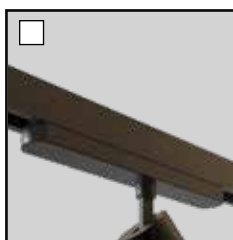

SD012RV
Track 220 0-10V Width 31mm

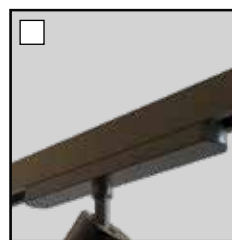

SD012RD
Track 220 DALI Width 31mm



SD012ARCA
RCA



SD012A
Fixing mounting simple
(except BA13)
Ø35mm H21mm

↓
**RCA ACCESSORY
NEXT PAGE**

**ACCESSORY (OPTIONAL)
TO BE ADDED TO THE
«FIXING MOUNTING SIMPLE»**



ACSFIPATER43XXENCC
Fixing mounting recessed
(driver out)
Ø43mm H34mm



ACSFIPATER60XXENCC
Fixing mounting recessed
(driver in)
Ø60mm H34mm

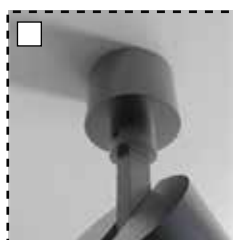

ACSFIPATER43XXAPPC
Fixing mounting ceiling
(driver out)
Ø43mm H30mm



ACSFIPATER70XXAPPC
Fixing mounting ceiling
(driver in)
Ø70mm H42.5mm

↓ EXAMPLE OF CONFIGURATION

SPOT D - FIXING MOUNTING SIMPLE + FIXING MOUNTING RECESSED Ø60 - **NOIR**
= SD001A-ACSFIPATER60**B**KENCC

Spot D12

RCA ACCESSORIES

REF : SD012



↓ RCA TRIMLESS SPOT MOUNTING

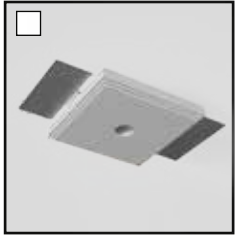

ACSD-RCA-PLA-13
RCA plug trimless recessed
plaster thickness 13mm

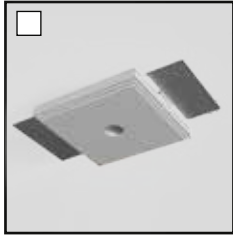

ACSD-RCA-PLA-18
RCA plug trimless recessed
plaster thickness 18mm

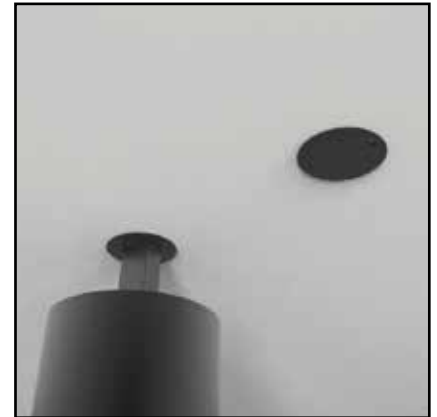
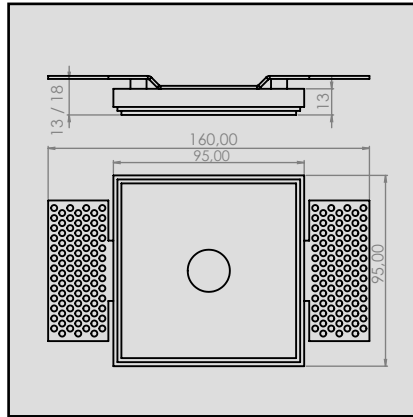

IN SITUATION



ACCOVERRCA TLXXC
Cover RCA trimless

↓ RCA TRIM SPOTS MOUNTING



ACSD-RCA
Female RCA trim

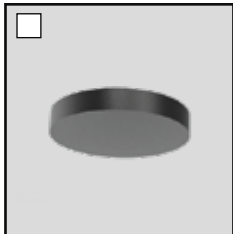

ACSD-RCA-CO
Cover RCA trim

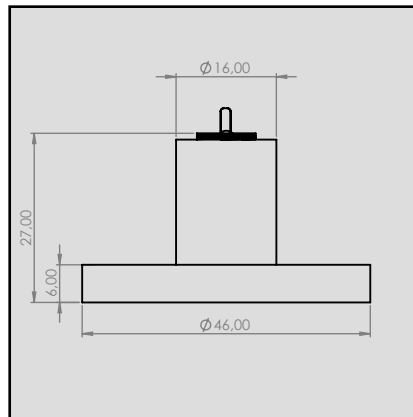

IN SITUATION

Spot D12

ACCESSORIES

REF : SD012

SPOT EN

↓ CONNECTORS INDEPENDENT CONNECTION TO BATTERIES

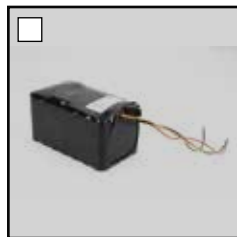

ACSD012COPLITHXX010
Pack Lithium 10,4Ah



ACSD012COCLITHXX35
Charger Pack Lithium
Charger 29,4V 3,5A

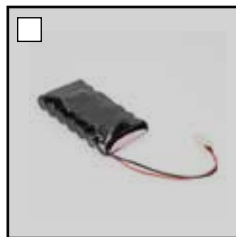

ACSD012COPLITHXX26
Pack Lithium 2,6Ah



ACSD012COCLITHXX06
Charger Pack Lithium
Charger 29,4V 0,6A

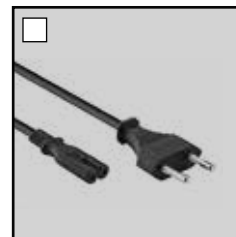

EUROPLUG

POWER SUPPLY CONNECTORS



ACSD012COCIRCPXX500
Piccolo circuit with sheath
heat-shrinkable

↓ OPTICAL ACCESSORIES

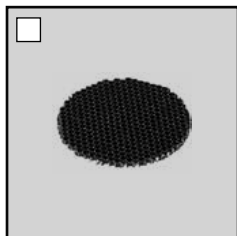

ACSD008OPNIDABBKD37C
Honey comb D40mm



ACSD012SNOOTBKL10C
Snoot spot D12 + 10mm