

Spot D15

REF : SD015

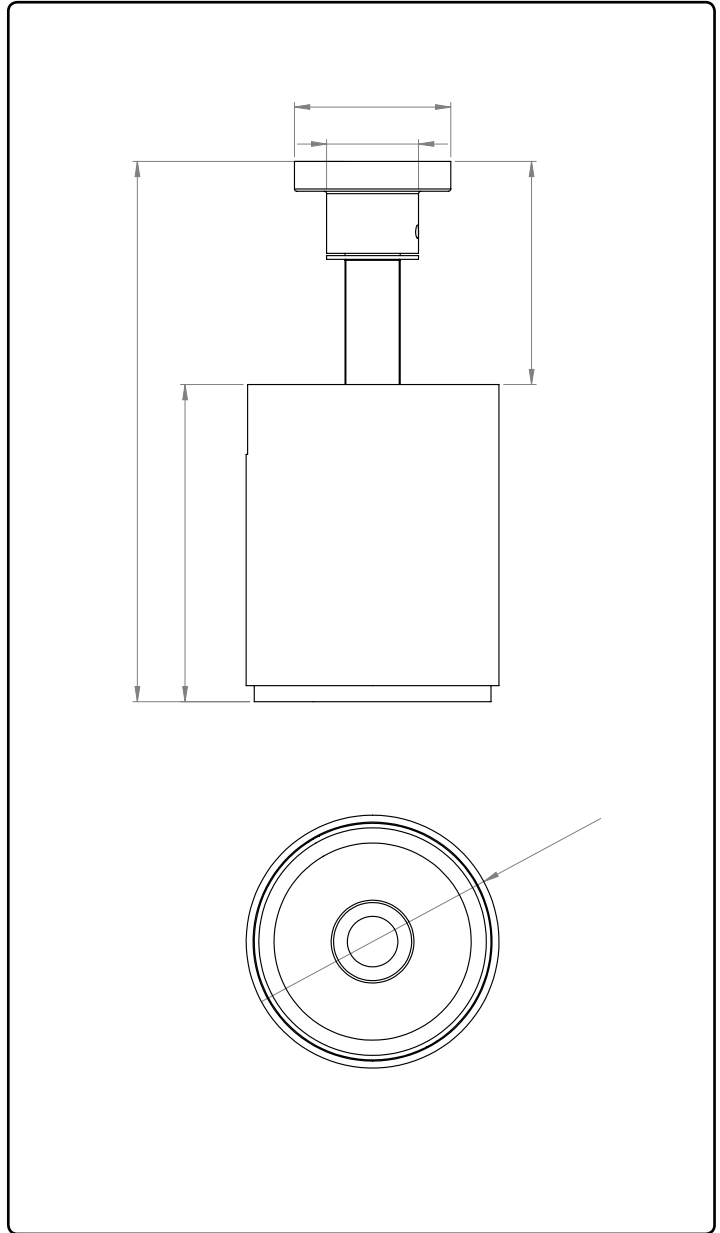

↓ PRODUCT DESCRIPTION

Spot D15 - Powerful LED accent and architectural round spotlight with adjustable aluminium body. Threaded safety lock. Passive heat dissipation for source temperature control preserving LED life. Interchangeable lenses by simple magnetic contact.

↓ OUTPUT (PEG)

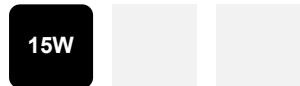

↓ OUTPUT (TRACK, RCA)



↓ CRI



↓ USE



↓ IP



↓ POWER SUPPLY (PEG)

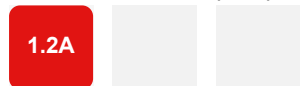

↓ LUMENS



↓ ADJUSTABLE DEGREES



↓ POWER SUPPLY (TRACK, RCA)

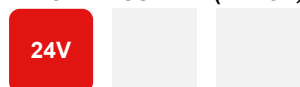

↓ DIMMING



↓ COLOUR TEMPERATURE



↓ STANDARDS COMPLIANCE



↓ COLOURS



↓ SOURCES

- Luminous flux according to Bining: **1500 lumens**
- Colour temperature : de **2700K to 4000K**
- Service Range: 70 % of nominal flux after 50 000 hours
- Colour Rendering Index: CRI 90

↓ OPTICAL

- PMMA acrylic lens, efficiency ~90%
- Available degrees : **10°, 15°, 25°, 35° et Elliptic**

↓ ELECTRICAL (on peg)

- Power supply **1.2A**
- Reversible polarity and hot plug
- Power consumption to **15W** max, excluding supply
- Electrical Classification : Class III SELV device

↓ ELECTRICAL (on tracks or RCA)

- Power supply 24V
- Electric transmission by magnetic contact
- Reversible polarity and hot plug
- Power consumption to **18W** max, excluding supply
- Electrical Classification : Class III SELV device

↓ MECHANICAL

- Electronic circuit encased in a fire-proof polycarbonate housin
- Fixing by magnetic contact (on track)
- Operating temperature : -5° +40°
- Articulating base
- ROHS components
- Interior use only

↓ SPECIFICITIES

- 3 years guarantee

↓ NOMENCLATURE

Product Ref.	SD015				
Specification	Simple peg		A		
	RCA		ARCA		
	Slim track magnet		SMA		
	Rail 220 1-10V		RV		
	RAIL 220 DALI		RD		
Degrees	10°			10	
	15°			15	
	25°			25	
	35°			35	
	Elliptic			ELL	
Colour	Black			BK	
	White			WH	
	Custom			CU	
Temperature	2700K				27
	3000K				30
	3500K				35
	4000K				40
REFERENCE	SD015	SMA	25	BK	27

BEAM ANGLE

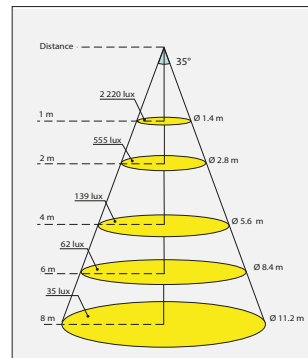
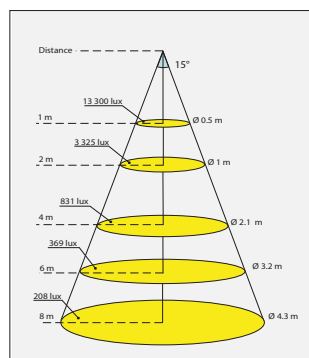
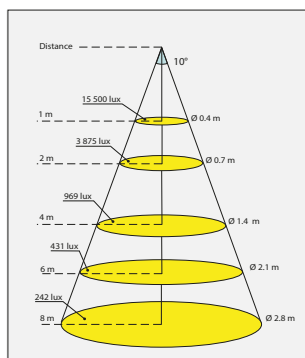

Spot D15

MOUNTING CONFIG.

REF : SD015



↓ MOUNTING CONFIGURATION



SD015A
Fixing mounting simple
(except BA13)
Ø35mm H21mm

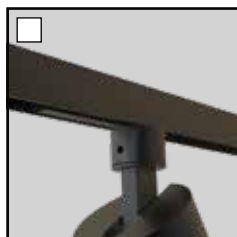

SD015SMA
Slim track Width 13mm

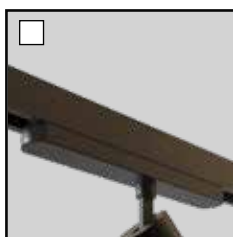

SD015RV
Track 220 0-10V Width 31mm

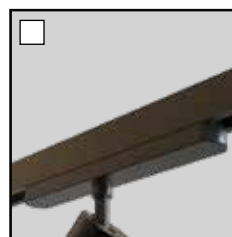

SD015RD
Track 220 DALI Width 31mm



SD015ARCA
RCA



**ACCESSORY (OPTIONAL)
TO BE ADDED TO THE
«FIXING MOUNTING SIMPLE»**

**RCA ACCESSORY
NEXT PAGE**



ACSFIPATER43XXENCC
Fixing mounting recessed
(driver out)
Ø43mm H34mm



ACSFIPATER60XXENCC
Fixing mounting recessed
(driver in)
Ø60mm H34mm



ACSFIPATER43XXAPPC
Fixing mounting ceiling
(driver out)
Ø43mm H30mm

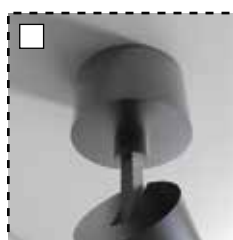

ACSFIPATER70XXAPPC
Fixing mounting ceiling
(driver in)
Ø70mm H42.5mm

↓ EXAMPLE OF CONFIGURATION

SPOT D - FIXING MOUNTING SIMPLE + FIXING MOUNTING RECESSED Ø60 - **NOIR**
= SD001A-ACSFIPATER60**B**KENCC

Spot D15

RCA ACCESSORIES

REF : SD015



↓ RCA TRIMLESS SPOT MOUNTING

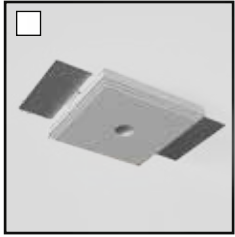

ACSD-RCA-PLA-13
RCA plug trimless recessed
plaster thickness 13mm

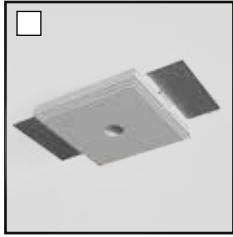

ACSD-RCA-PLA-18
RCA plug trimless recessed
plaster thickness 18mm

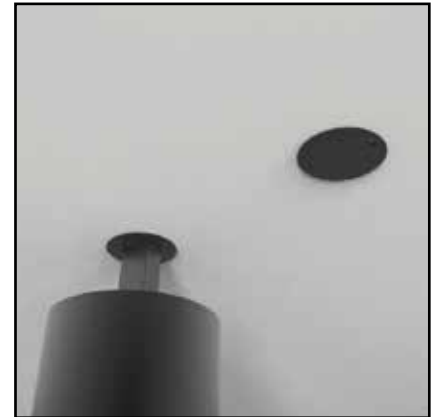
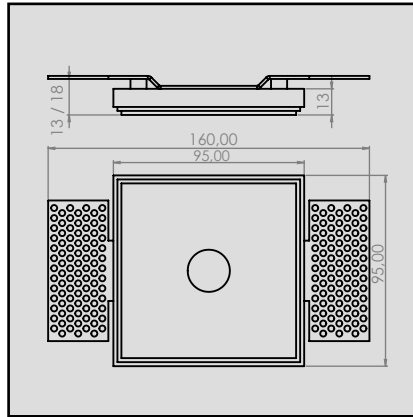

IN SITUATION



ACCOVERRCA TLXXC
Cover RCA trimless

↓ RCA TRIM SPOTS MOUNTING



ACSD-RCA
Female RCA trim

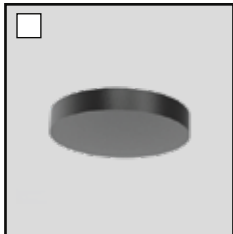

ACSD-RCA-CO
Cover RCA trim

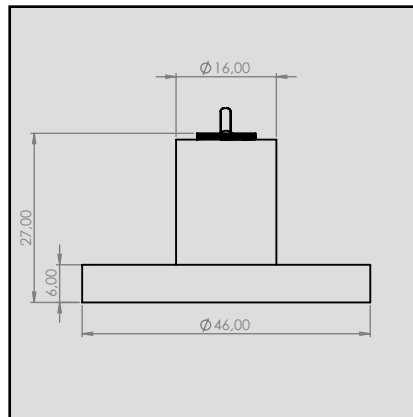

IN SITUATION

Spot D15

ACCESSORIES

REF : SD015

SPOT EN

↓ CONNECTORS INDEPENDENT CONNECTION TO BATTERIES

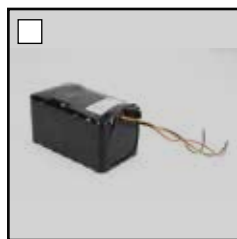

ACSD015COPLITHXX010
Pack Lithium 10,4Ah



ACSD015COCLITHXX35
Charger Pack Lithium
Charger 29,4V 3,5A

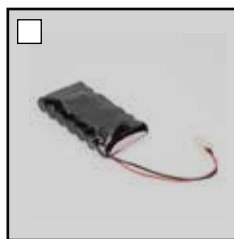

ACSD015COPLITHXX26
Pack Lithium 2,6Ah



ACSD015COCLITHXX06
Charger Pack Lithium
Charger 29,4V 0,6A

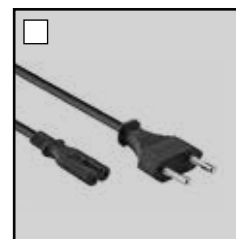

EUROPLUG

POWER SUPPLY CONNECTORS



ACSD015COCIRCPXX500
Piccolo circuit with sheath
heat-shrinkable

↓ OPTICAL ACCESSORIES

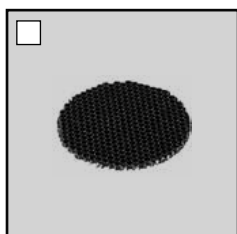

ACSD015NIDABBK050C
Honey comb D49.5mm



ACSD015OPSNOOTBKL10C
Snoot spot D15 + 10mm