

↓ PRODUCT DESCRIPTION

Spot D12 - Powerful LED accent and architectural round spotlight with adjustable aluminium body. Threaded safety lock. Passive heat dissipation for source temperature control preserving LED life. Interchangeable lenses (15°, 25°, 40°, 50° Elliptical) by simple magnetic contact.

↓ OUTPUT (PEG)

12W

↓ OUTPUT (TRACK, RCA)

14.5W

↓ CRI

IRC90

↓ USE

↓ IP

IP 40

↓ POWER SUPPLY (PEG)

1A

↓ LUMENS

1200lm

↓ ADJUSTABLE DEGREES

15° 25° 40° 50° ELL

↓ POWER SUPPLY (TRACK, RCA)

24V

↓ DIMMING

1-10V BALL CASAMBI DMX

↓ COLOUR TEMPERATURE

2700K 3000K 3500K 4000K

↓ STANDARDS COMPLIANCE

EN 62471 EN 60598-1 EN 60598-2 CE III ETL

↓ COLOURS

BK WH CUSTOM

↓ SOURCES

- Luminous flux according to Bining: 1200lumens
- Colour temperature : de 2700K to 4000K
- Service Range: 70 % of nominal flux after 50 000 hours
- Colour Rendering Index: CRI 90

↓ OPTICAL

- PMMA acrylic lens, efficiency ~90%
- Adjustable degrees : 15°, 25°, 40°, 50° and Elliptic

↓ ELECTRICAL (on peg)

- Power supply 1A
- Reversible polarity and hot plug
- Power consumption to 12W max, excluding supply
- Electrical Classification : Class III SELV device

↓ ELECTRICAL (on tracks or RCA)

- Power supply 24V
- Electric transmission by magnetic contact
- Reversible polarity and hot plug
- Power consumption to 14.5W max, excluding supply
- Electrical Classification : Class III SELV device

↓ MECHANICAL

- Electronic circuit encased in a fire-proof polycarbonate housin
- Fixing by magnetic contact (on track)
- Operating temperature : -5° +40°
- Articulating base
- ROHS components
- Interior use only

↓ SPECIFICITIES

- 3 years guarantee

↓ SPOT NOMENCLATURE

Product Ref.	SD012		
Product specification	Simple peg	A	
	RCA	ARCA	
	Piccolo track	P	
	Slim track magnet	SMA	
	220 0-10V track	RV	
	220 DALI track	RD	
Colour	Black	BK	
	White	WH	
	Custom	CU	
Temperature	2700K		27
	3000K		30
	3500K		35
	4000K		40
Degrees	15°		15
	25°		25
	40°		40
	50°		50
	Elliptic		ELL
REFERENCE	SD012	A	BK 27 15

↓ MOUNTING NOMENCLATURE

Mounting spec.	Mounting recessed Ø43	ACSFIPATER43	ENCC
	Mounting recessed Ø60	ACSFIPATER60	ENCAC
	Mounting ceiling Ø50	ACSFIPATER50	APPC
	Mounting ceiling X1spot	ACSFIPA1704030	AP1C
	Mounting ceiling X2spot	ACSFIPA1704030	AP2C
Colour	Black		BK
	White		WH
	Custom		CU
REFERENCE		ACSFIPATER43	BK ENCC

↓ RCA TRIM NOMENCLATURE

Product reference		ACSDRCA	APPC
Colour	Black		BK
	White		WH
	Custom		CU
REFERENCE		ACSDRCA	BK APPC

↓ NOMENCLATURES PATERE RCA TRIMLESS

Référence produit	ACSDRCAENCC
-------------------	-------------

Spot D12

MOUNTING CONFIG.

REF : SD012

SPOT EN

↓ MOUNTING CONFIGURATION

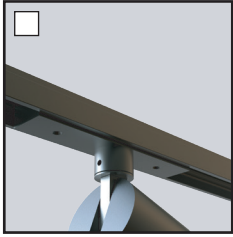

SD012P
Piccolo track Width 27mm

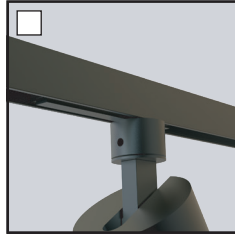

SD012SMA
Slim track Width 13mm

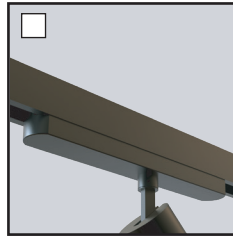

SD012RV
220 0-10V track Width 31mm

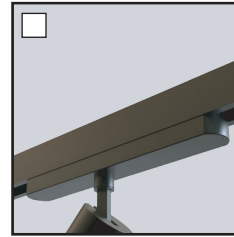

SD012RD
220 DALI track Width 31mm

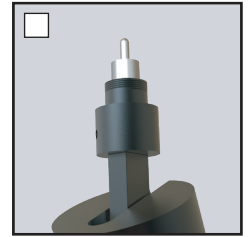

SD012ARCA
RCA

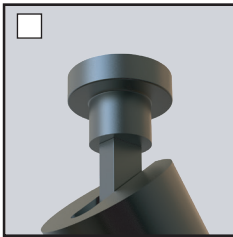

SD012A
Simple peg
Ø35mm H21mm

↓ Beam angle

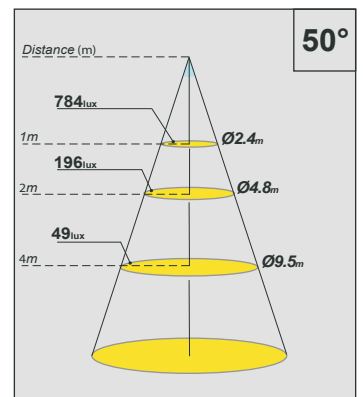
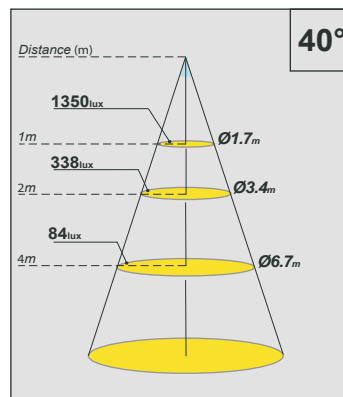
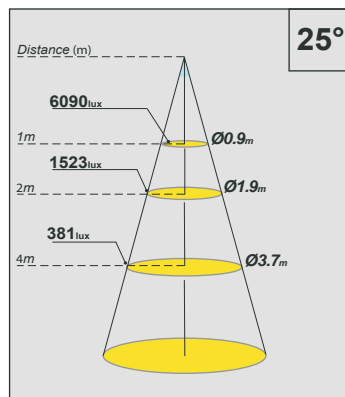
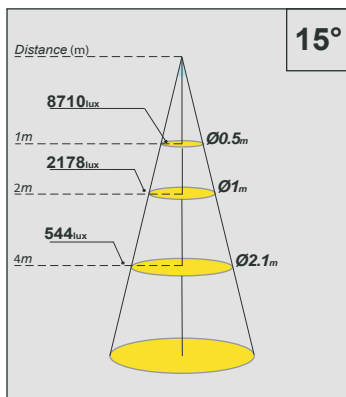

Spot D12

ORDER REFERENCE

REF : SD012



ORDER REFERENCE (MOUNTING NOMENCLATURE)



SD012-A-BK-27
Spot D12 - Peg - Black(BK) - 2700K(27).

+

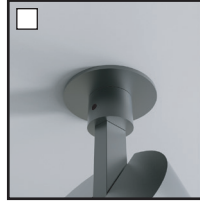

ACS FIPATER43XXENCC
Fixing mounting recessed
Ø43mm H34mm

or

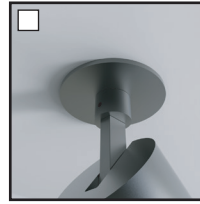

ACS FIPATER60XXENCAC
Fixing mounting recessed
Ø60mm H34mm

or

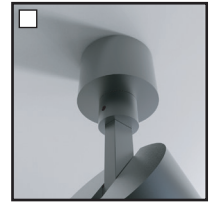

ACS FIPATER50XXAPPC
Fixing mounting ceiling
Ø50mm H30mm

or

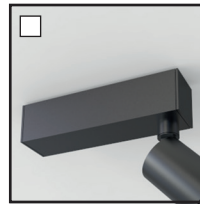

ACS FIPA1704030XXAP1C
Fixing mounting ceiling
(driver in)
x1 spot : 170x40x30mm

or

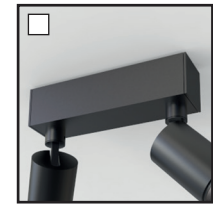

ACS FIPA1704030WHAP2C
Fixing mounting ceiling
(driver in)
x2 spots : 170x40x30mm

ORDER REFERENCE (RCA TRIM NOMENCLATURE)

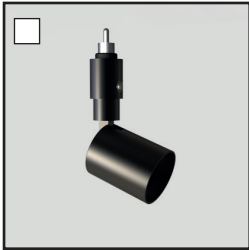

SD012-ARCA-BK-27
Spot D12 - RCA - Black(BK) - 2700K(27).

+

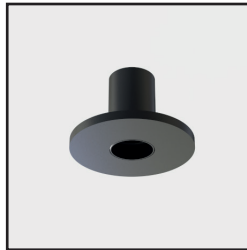

ACS DRCA BK APPC
Mounting RCA trim - Black(BK)
(Ø50mm)

=



ORDER REFERENCE (RCA TRIMLESS NOMENCLATURE)

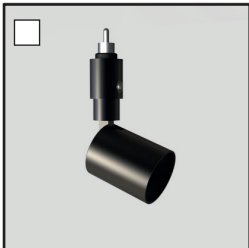

SD012-ARCA-BK-27
Spot D12 - RCA - Black(BK) - 2700K(27).

+

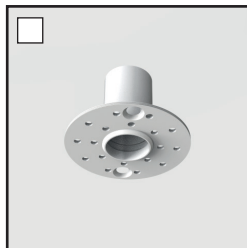

ACS DRCA ENCC
Mounting RCA trimless

=



Spot D12

ACCESSORIES

REF : SD012

SPOT EN

↓ RCA ACCESSORIES

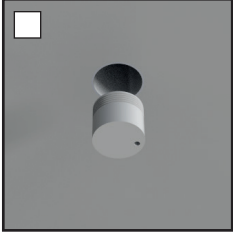

ACSDRCABOUCHONXXC
Finishing cap for RCA trim &
trimless mounting

↓ POWER SUPPLY CONNECTORS

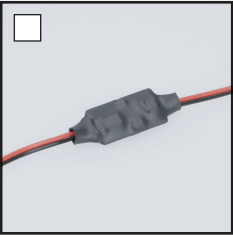

ACSD012COCIRCPXX500
Piccolo circuit with sheath
heat-shrinkable

↓ OPTICAL ACCESSORIES

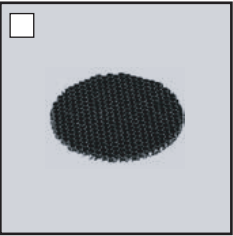

ACSD008OPNIDABBKD37C
Honeycomb Ø40mm

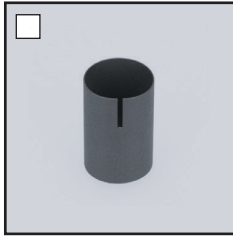

ACSD012SNOOTBKL10C
Snoot spot D12 +10mm